

## N-channel 80 V, 1.6 mΩ max., 220 A STripFET F8 Power MOSFET in a PowerFLAT 5x6 package

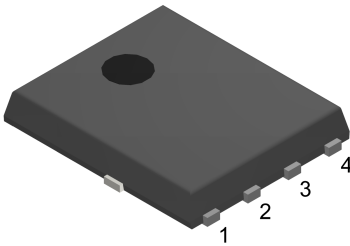

PowerFLAT 5x6

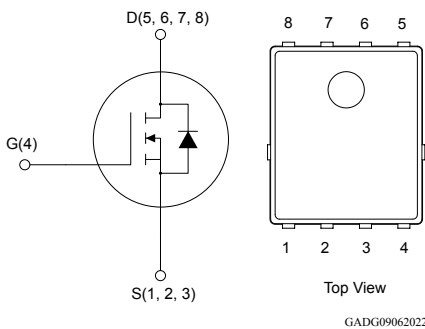

### Features

Order code	V <sub>DS</sub>	R <sub>DS(on)</sub> max.	I <sub>D</sub>
STL190N8F8	80 V	1.6 mΩ	220 A

- MSL1 grade
- 175 °C maximum operating junction temperature
- 100% avalanche tested
- Low gate charge Q<sub>G</sub>

### Applications

- Server and Telecom power
- Industrial battery management system (BMS)
- Power tools
- Drones

### Description

The **STL190N8F8** is a 80 V N-channel enhancement mode Power MOSFET designed in STripFET F8 technology featuring an enhanced trench gate structure. It ensures a state-of-the-art of figure of merit for very low on-state resistance while reducing internal capacitances and gate charge for faster and more efficient switching.



#### Product status link

[STL190N8F8](#)

#### Product summary

Order code	STL190N8F8
Marking <sup>(1)</sup>	190N8F8
Package	PowerFLAT 5x6
Packing	Tape and reel

1. For engineering samples marking, see the Section 3.3: PowerFLAT 5x6 marking information.

# 1 Electrical ratings

**Table 1. Absolute maximum ratings (at  $T_C = 25\text{ °C}$  unless otherwise specified)**

Symbol	Parameter	Value	Unit
$V_{DS}$	Drain-source voltage	80	V
$V_{GS}$	Gate-source voltage	$\pm 20$	V
$I_D^{(1)}$	Drain current (continuous) at $T_C = 25\text{ °C}^{(2)}$	220	A
	Drain current (continuous) at $T_C = 100\text{ °C}^{(2)}$	155	
	Drain current (continuous) at $T_C = 25\text{ °C}^{(3)}$	120	
$I_{DM}^{(1)(2)(4)}$	Drain current (pulsed), $t_p = 10\text{ }\mu\text{s}$	880	A
$P_{TOT}$	Total power dissipation at $T_C = 25\text{ °C}$	167	W
$I_{AS}$	Single pulse avalanche current (pulse width limited by maximum junction temperature)	60	A
$E_{AS}$	Single pulse avalanche energy (starting $T_J = 25\text{ °C}$ , $I_D = 60\text{ A}$ , $R_{Gmin} = 25\text{ }\Omega$ )	270	mJ
$T_J$	Operating junction temperature range	-55 to 175	$^{\circ}\text{C}$
$T_{stg}$	Storage temperature range		$^{\circ}\text{C}$

1. Specified by design, not tested in production.
2. This is the theoretical current value only related to the silicon.
3. This current value is limited by package.
4. Pulse width is limited by safe operating area.

**Table 2. Thermal data**

Symbol	Parameter	Value	Unit
$R_{thJA}^{(1)}$	Thermal resistance, junction-to-ambient (on 2s2p FR-4 board vertical in still area)	16.4	$^{\circ}\text{C/W}$
$R_{thJC}$	Thermal resistance, junction-to-case	0.9	$^{\circ}\text{C/W}$

1. Defined according to JEDEC standards (JESD51-5, -7).

## 2 Electrical characteristics

$T_J = 25\text{ °C}$  unless otherwise specified.

**Table 3. On/off states**

Symbol	Parameter	Test conditions	Min.	Typ.	Max.	Unit
$V_{(BR)DSS}$	Drain-source breakdown voltage	$V_{GS} = 0\text{ V}$ , $I_D = 1\text{ mA}$	80	-	-	V
$I_{DSS}$	Zero gate voltage drain current	$V_{DS} = 80\text{ V}$ , $V_{GS} = 0\text{ V}$	-	-	1	$\mu\text{A}$
		$V_{DS} = 80\text{ V}$ , $V_{GS} = 0\text{ V}$ , $T_J = 125\text{ °C}^{(1)}$	-	-	100	
$I_{GSS}$	Gate-body leakage current	$V_{GS} = 20\text{ V}$ , $V_{DS} = 0\text{ V}$	-	-	100	nA
$V_{GS(th)}$	Gate threshold voltage	$V_{DS} = V_{GS}$ , $I_D = 250\text{ }\mu\text{A}$	2	-	4	V
$R_{DS(on)}$	Static drain-source on-resistance	$V_{GS} = 10\text{ V}$ , $I_D = 60\text{ A}$	-	1.55	1.6	m $\Omega$
$R_G^{(1)}$	Gate resistance		-	0.9	-	$\Omega$

1. Specified by design and evaluated by characterization, not tested in production.

**Table 4. Dynamic**

Symbol	Parameter	Test conditions	Min.	Typ.	Max.	Unit
$C_{iss}^{(1)}$	Input capacitance	$V_{DS} = 40\text{ V}$ , $f = 1\text{ MHz}$ , $V_{GS} = 0\text{ V}$	-	6000	-	pF
$C_{oss}^{(1)}$	Output capacitance		-	1150	-	pF
$C_{rss}^{(1)}$	Reverse transfer capacitance		-	32	-	pF
$Q_g^{(1)}$	Total gate charge	$V_{DD} = 40\text{ V}$ , $I_D = 60\text{ A}$ , $V_{GS} = 0\text{ to }10\text{ V}$	-	85	-	nC
$Q_{gs}^{(1)}$	Gate-source charge		-	28	-	nC
$Q_{gd}^{(1)}$	Gate-drain charge		-	17	-	nC
$Q_{g(sync)}$	Total gate charge, sync. MOSFET	$V_{DS} = 0.1\text{ V}$ , $V_{GS} = 0\text{ to }10\text{ V}$	-	69	-	nC
$Q_{oss}$	Output charge	$V_{DD} = 40\text{ V}$ , $V_{GS} = 0\text{ V}$	-	103	-	nC

1. Specified by design and evaluated by characterization, not tested in production.

**Table 5. Switching times**

Symbol	Parameter	Test conditions	Min.	Typ.	Max.	Unit
$t_{d(on)}^{(1)}$	Turn-on delay time	$V_{DD} = 40\text{ V}$ , $I_D = 60\text{ A}$ , $R_G = 4.7\text{ }\Omega$ , $V_{GS} = 10\text{ V}$	-	22	-	ns
$t_r^{(1)}$	Rise time		-	14	-	ns
$t_{d(off)}^{(1)}$	Turn-off delay time		-	54	-	ns
$t_f^{(1)}$	Fall time		-	15	-	ns

1. Specified by design and evaluated by characterization, not tested in production.

**Table 6. Source-drain diode**

Symbol	Parameter	Test conditions	Min.	Typ.	Max.	Unit
$I_{SD}^{(1)(2)}$	Forward on current (continuous)	$T_C = 25\text{ °C}$	-	-	103	A
$V_{SD}$	Forward on voltage	$I_{SD} = 60\text{ A}, V_{GS} = 0\text{ V}$	-	-	1.3	V
$t_{rr}^{(1)}$	Reverse recovery time	$I_D = 60\text{ A}, di/dt = 100\text{ A}/\mu\text{s}, V_{DD} = 64\text{ V}$	-	56	-	ns
$Q_{rr}^{(1)}$	Reverse recovery charge		-	73	-	nC
$I_{RRM}^{(1)}$	Reverse recovery current		-	2.6	-	A

1. Specified by design and evaluated by characterization, not tested in production.
2. This is the theoretical current value only related to the silicon.

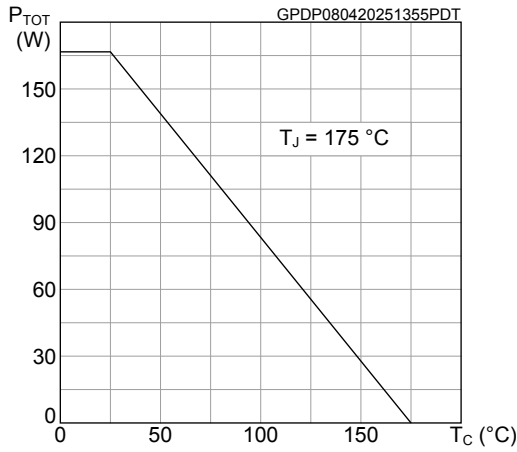
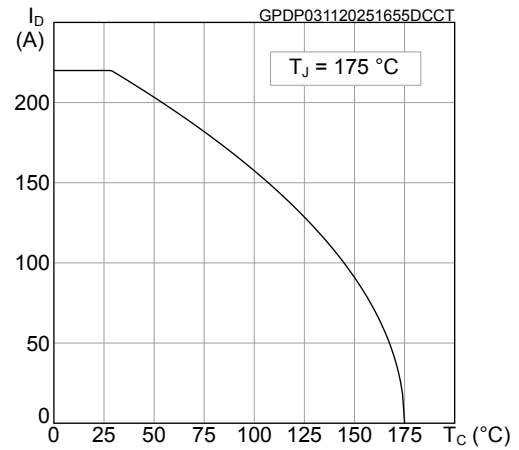
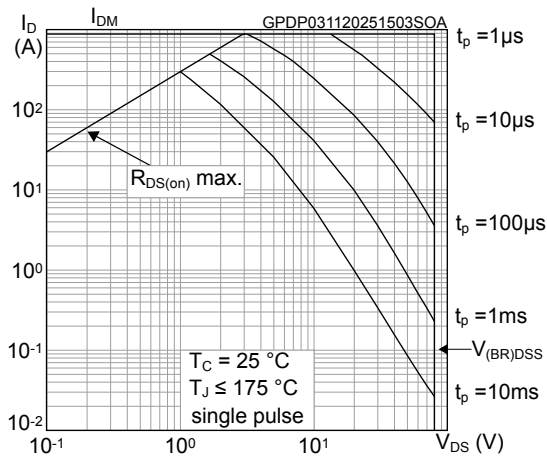
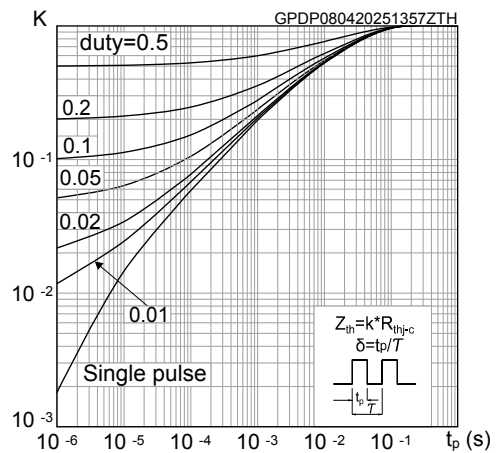
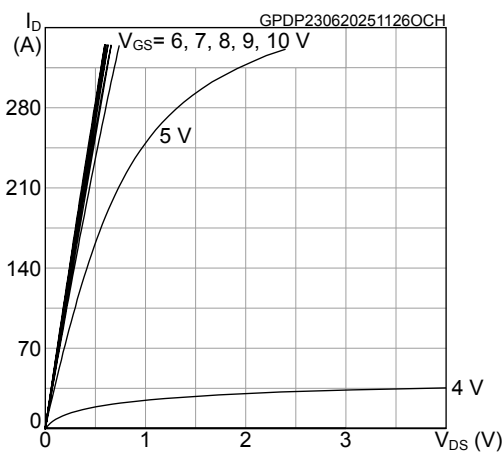
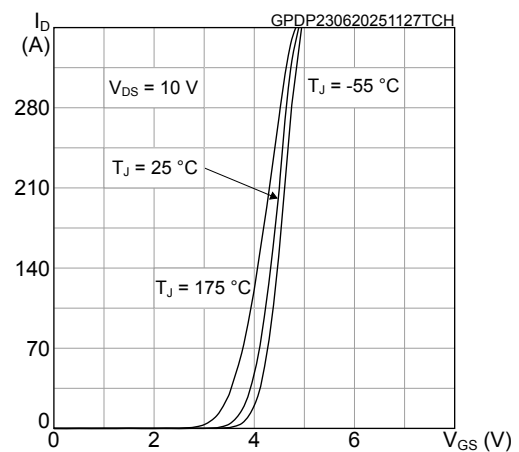
**2.1 Electrical characteristics (curves)**
**Figure 1. Total power dissipation**

**Figure 2. Drain current vs case temperature**

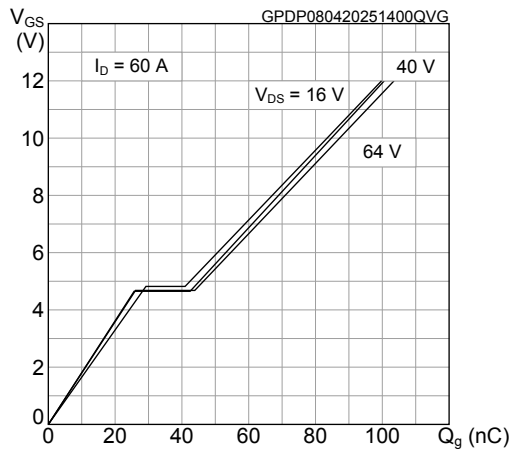
**Figure 3. Safe operating area**

**Figure 4. Normalized transient thermal impedance**

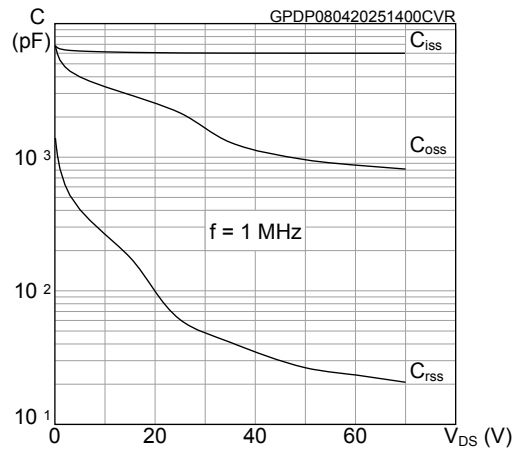
**Figure 5. Typical output characteristics**

**Figure 6. Typical transfer characteristics**

**Figure 7. Typical gate charge characteristics**



**Figure 8. Typical capacitance characteristics**



**Figure 9. Avalanche characteristics**

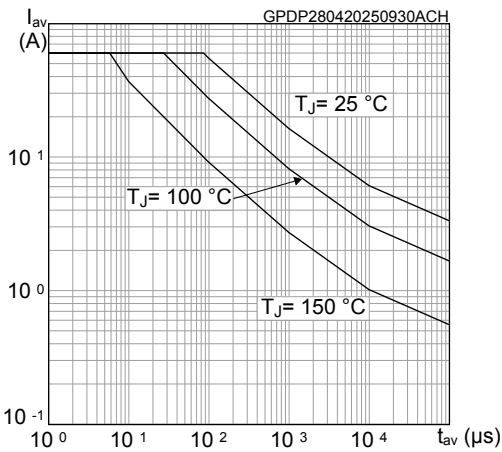

**Figure 10. Avalanche energy**

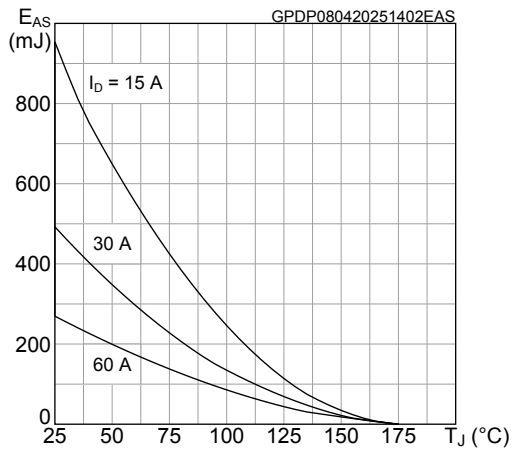

**Figure 11. Typical on-resistance vs. gate-source voltage**

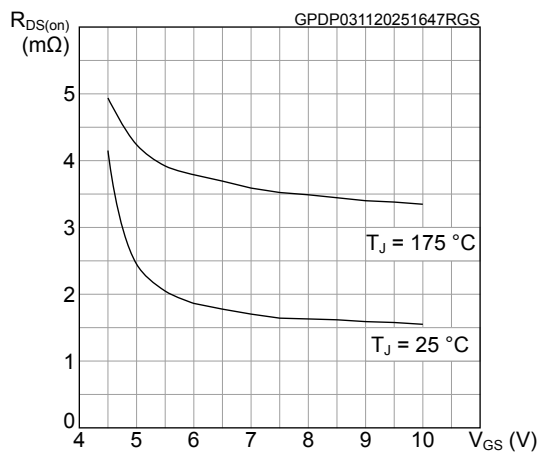

**Figure 12. Typical drain-source on-resistance**

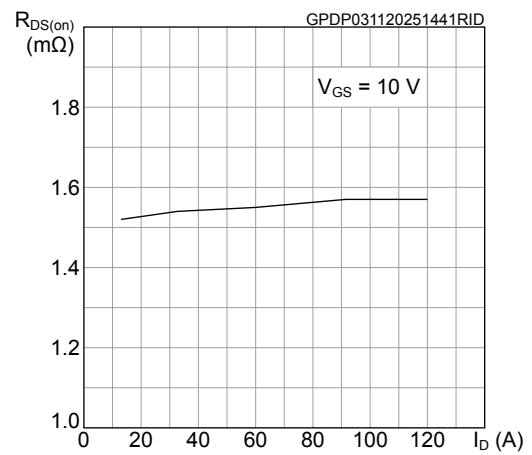

**Figure 13. Normalized on-resistance vs temperature**

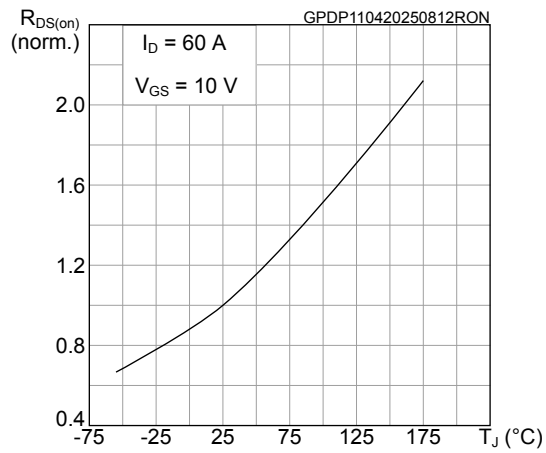

**Figure 14. Normalized gate threshold voltage vs temperature**

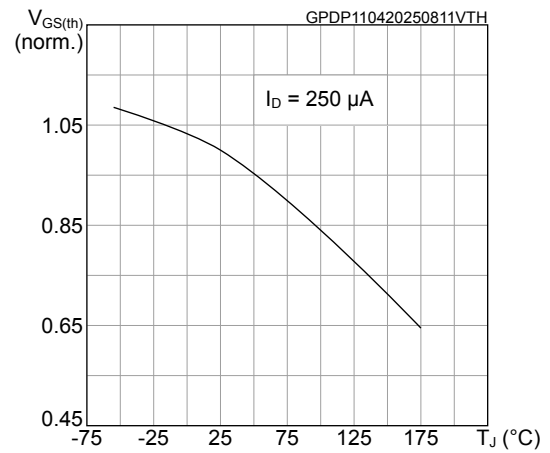

**Figure 15. Typical reverse diode forward characteristics**

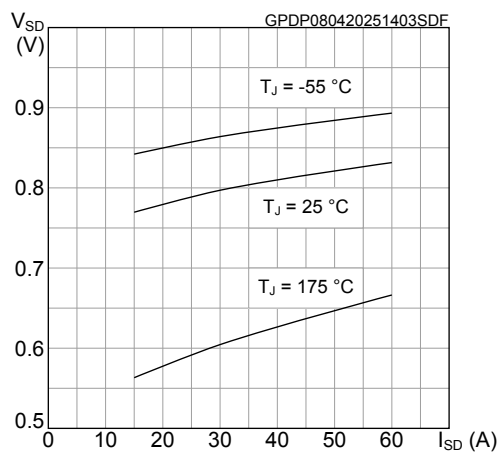

**Figure 16. Normalized  $V_{(BR)DSS}$  vs temperature**

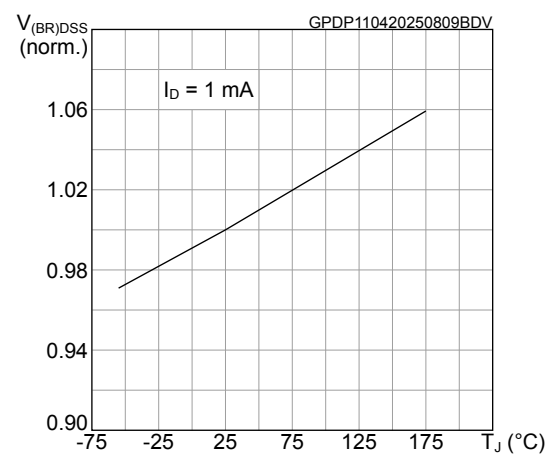

### 3 Package information

To meet environmental requirements, ST offers these devices in different grades of **ECOPACK** packages, depending on their level of environmental compliance. ECOPACK specifications, grade definitions, and product status are available at: [www.st.com](http://www.st.com). ECOPACK is an ST trademark.

#### 3.1 PowerFLAT 5x6 type B package information

**Figure 17. PowerFLAT 5x6 type B package outline**

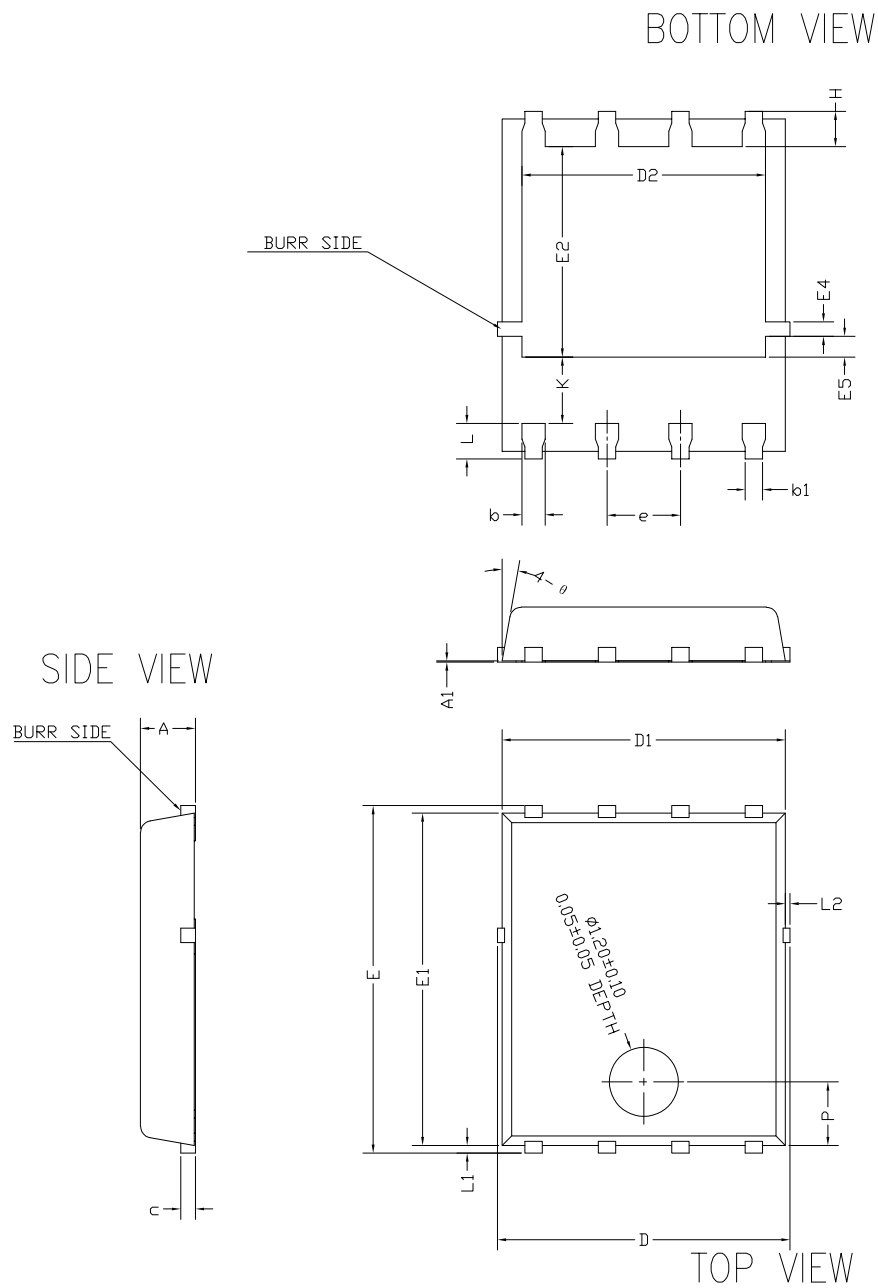

Drawing\_8472137\_typeB rev5

**Table 7. PowerFLAT 5x6 type B mechanical data**

Dim.	mm		
	Min.	Typ.	Max.
A	0.90	0.95	1.00
A1		0.02	
b	0.35	0.40	0.45
b1		0.30	
c	0.21	0.25	0.34
D	4.80		5.10
D1	4.80	4.90	5.00
D2	4.01	4.21	4.31
e	1.17	1.27	1.37
E	5.90	6.00	6.10
E1	5.70	5.75	5.80
E2	3.54	3.64	3.74
E4	0.15	0.25	0.35
E5	0.26	0.36	0.46
H	0.51	0.61	0.71
K	0.95		
L	0.51	0.61	0.71
L1	0.06	0.13	0.20
L2			0.10
P	1.00	1.10	1.20
$\theta$	8°	10°	12°

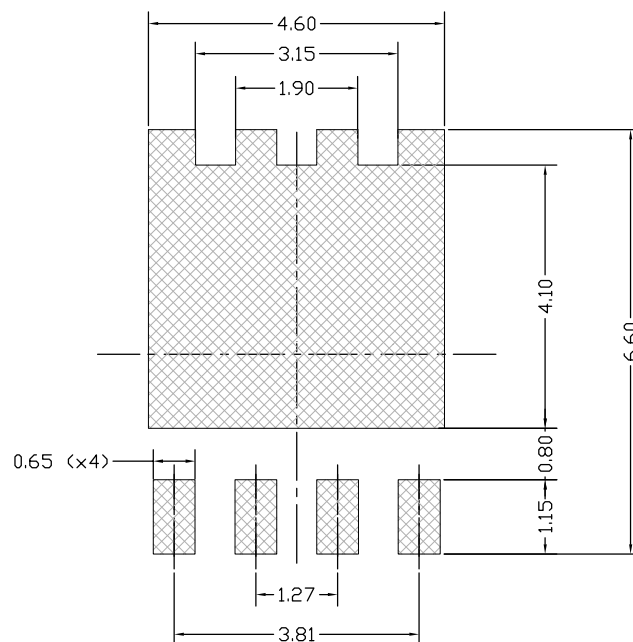
**Figure 18. PowerFLAT 5x6 recommended footprint (dimensions are in mm)**

Footprint\_8472137\_typeB rev5

### 3.2 PowerFLAT 5x6 packing information

**Figure 19. PowerFLAT 5x6 tape (dimensions are in mm)**

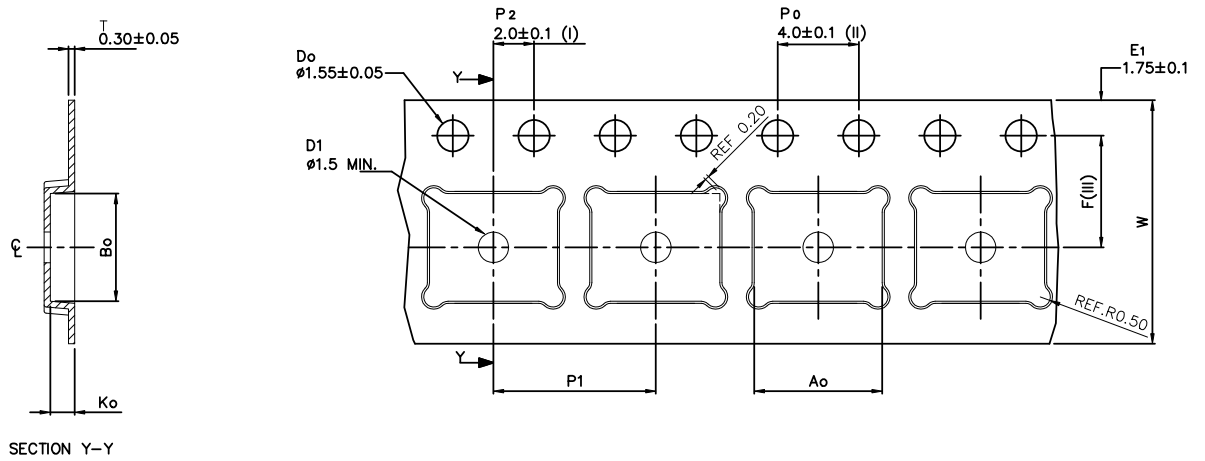

Ao	6.30 +/- 0.1
Bo	5.30 +/- 0.1
Ko	1.20 +/- 0.1
F	5.50 +/- 0.1
P1	8.00 +/- 0.1
W	12.00 +/- 0.3

(I) Measured from centreline of sprocket hole to centreline of pocket.

(II) Cumulative tolerance of 10 sprocket holes is  $\pm 0.20$ .

(III) Measured from centreline of sprocket hole to centreline of pocket

Base and bulk quantity 3000 pcs  
All dimensions are in millimeters

8234350\_Tape\_rev\_C

**Figure 20. PowerFLAT 5x6 package orientation in carrier tape**

Pin 1 identification

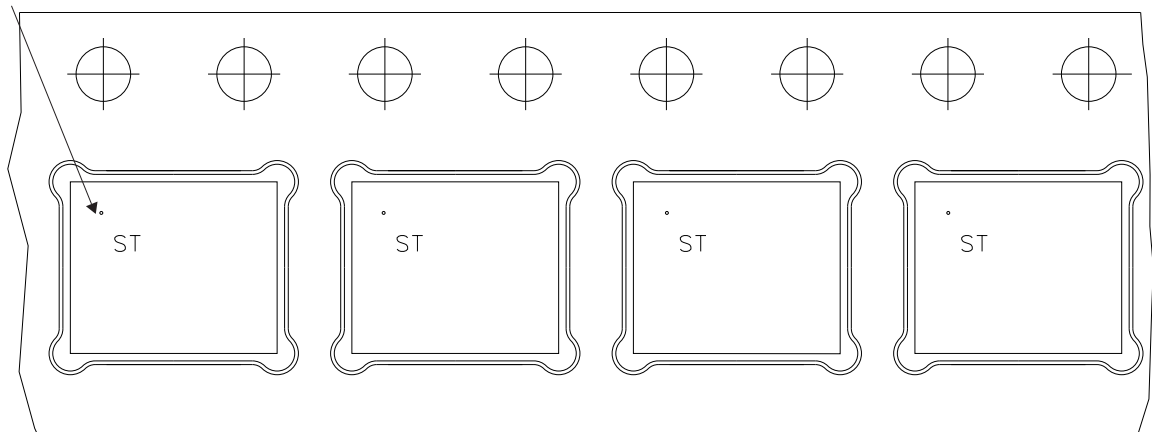

**Figure 21. PowerFLAT 5x6 reel**

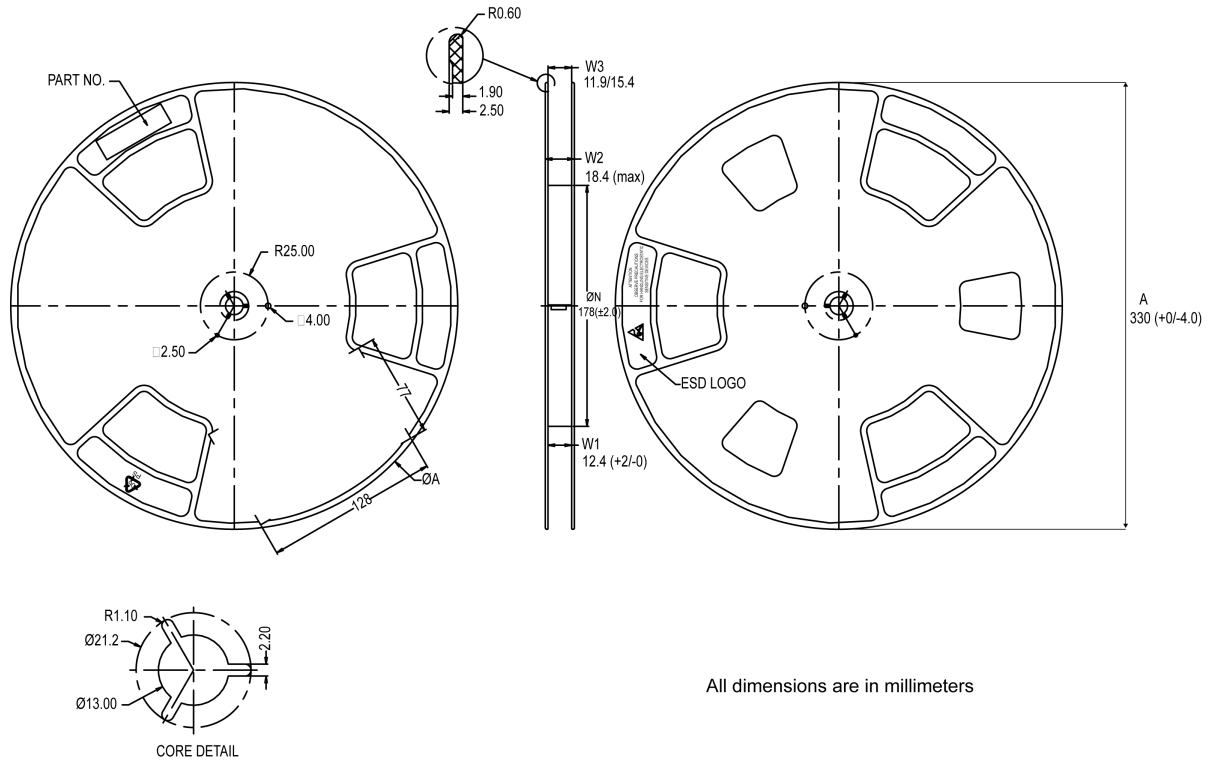

All dimensions are in millimeters

8234350\_Reel\_rev\_C

### 3.3 PowerFLAT 5x6 marking information

Figure 22. PowerFLAT 5x6 marking information

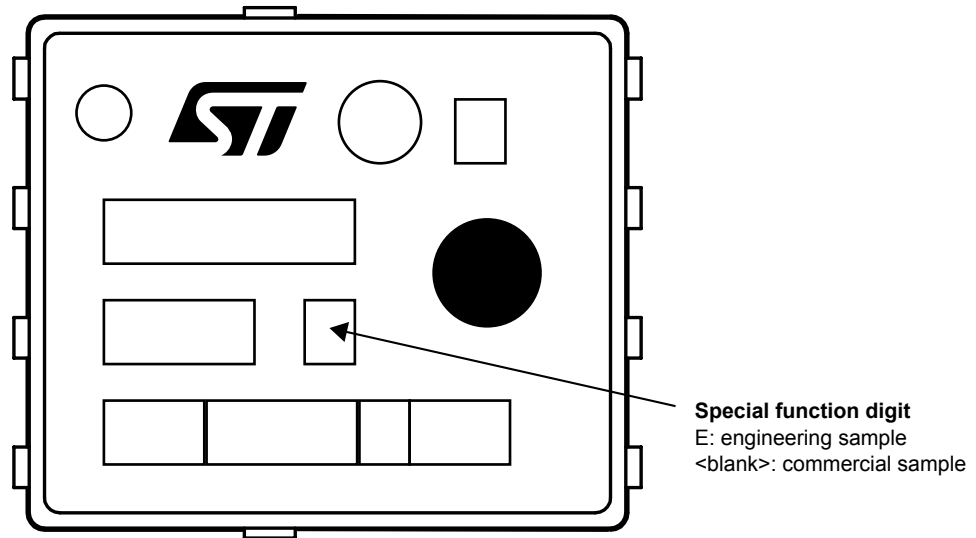

*Note:* **Engineering Samples:** these samples can be clearly identified by a dedicated special symbol in the marking of each unit. These samples are intended to be used for electrical compatibility evaluation only; usage for any other purpose may be agreed only upon written authorization by ST. ST is not liable for any customer usage in production and/or in reliability qualification trials.

**Commercial Samples:** fully qualified parts from ST standard production with no usage restrictions.

## Revision history

**Table 8. Document revision history**

Date	Revision	Changes
02-Oct-2025	1	First release.
17-Oct-2025	2	Updated marking in <i>Section Device summary</i> .
04-Nov-2025	3	Updated title and features on cover page. Updated Table 1. Absolute maximum ratings (at $T_C = 25\text{ °C}$ unless otherwise specified) and Table 3. On/off states. Added Section 2.1: Electrical characteristics (curves). Minor text changes.

## Contents

<b>1</b>	<b>Electrical ratings</b> .....	<b>2</b>
<b>2</b>	<b>Electrical characteristics</b> .....	<b>3</b>
<b>2.1</b>	Electrical characteristics (curves) .....	<b>5</b>
<b>3</b>	<b>Package information</b> .....	<b>8</b>
<b>3.1</b>	PowerFLAT 5x6 type B package information .....	<b>8</b>
<b>3.2</b>	PowerFLAT 5x6 packing information .....	<b>10</b>
<b>3.3</b>	PowerFLAT 5x6 marking information .....	<b>12</b>
	<b>Revision history</b> .....	<b>13</b>

**IMPORTANT NOTICE – READ CAREFULLY**

STMicroelectronics NV and its subsidiaries (“ST”) reserve the right to make changes, corrections, enhancements, modifications, and improvements to ST products and/or to this document at any time without notice.

In the event of any conflict between the provisions of this document and the provisions of any contractual arrangement in force between the purchasers and ST, the provisions of such contractual arrangement shall prevail.

The purchasers should obtain the latest relevant information on ST products before placing orders. ST products are sold pursuant to ST's terms and conditions of sale in place at the time of order acknowledgment.

The purchasers are solely responsible for the choice, selection, and use of ST products and ST assumes no liability for application assistance or the design of the purchasers' products.

No license, express or implied, to any intellectual property right is granted by ST herein.

Resale of ST products with provisions different from the information set forth herein shall void any warranty granted by ST for such product.

If the purchasers identify an ST product that meets their functional and performance requirements but that is not designated for the purchasers' market segment, the purchasers shall contact ST for more information.

ST and the ST logo are trademarks of ST. For additional information about ST trademarks, refer to [www.st.com/trademarks](http://www.st.com/trademarks). All other product or service names are the property of their respective owners.

Information in this document supersedes and replaces information previously supplied in any prior versions of this document.

© 2025 STMicroelectronics – All rights reserved